



UV-C DISINFECTION *EQUIPMENT FOR THE TREATMENT OF WATER*



MANUAL OF INSTALLATION, USE AND SERVICING



CONTENS

1.	Introduction	2
2.	General Principles and Safety Instructions	3
3.	Instructions for installation and setting at work	4
3.1	Suggested Installation Scheme	5
4.	UV Chamber Installation	6
4.1	UV chamber assembling	6
4.2	UV Chamber Detailed Drawing	9
5.	Electrical panel installation and operation	10
5.1	Control Panel Description	10
5.2	Electrical panel installation and operation	11
5.3	Switch ON / Switch OFF the lamps	11
5.2	Control Panel Detailed Drawing	12
6.	LCD Electrical Board Description	13
6.1	Single-lamp LCD electrical board description	13
6.2	Two-Lamp LCD electrical board description	14
6.3	LCD Display board Description	15
7.	Display Information (Troubleshooting)	16
8.	Maintenance	23
9.	Warranty Conditions	24
10.	Declaration of Conformity EC	25

1. Introduction

Warning: This equipment requires regular maintenance to ensure the requirements of the water treated and the maintenance of the improvements as stated by the manufacturer.

These operating instructions contain important information for the operation and maintenance of the equipment.

Please ensure that these operating instructions are carefully read by all relevant persons before putting into operation, to ensure the safe use of the UV system. The operating instructions are an integral part of the equipment supply.

Before putting into operation, all the conditions necessary for safe operation of the equipment must be fulfilled.

The installation, commissioning and maintenance of the equipment should only be carried out by qualified personnel.

The equipment should only be operated by authorized personnel who have been trained accordingly.

No modifications should be made to the equipment without consulting Oceanlife, as this could affect the safe operation of the unit. Oceanlife shall not be held responsible for damage resulting from unapproved modifications.



INSTRUCTION:

The operating instructions are to be kept where they will be accessible for operating and maintenance personnel.

2. General Principles and Safety Instructions

Information about UV irradiation:

The UV disinfection system of the LCD series have been planned specially for destroying harmful bacteria and viruses present in your water.

Their working is based on a physical principle which is a warranty of security: the output of ultra-violet irradiation.

The UV light given out by special mercury vapours lamps (UV-C rays $\lambda = 254\text{nm}$) is highly germicidal because it interacts with DNA and RNA, at a molecular level.

The deep bio-structural disorder caused by such irradiation interferes with the development and the ability of reproduction of every kind of micro-organism, making it harmless.

Generally it is better to mount a pre-filter before the UV sterilizer, in this way the impurities of every nature and consistence are kept.

This system comes to be necessary if we want to have a high degree of sterilization, infact the non-filtration and removal of suspended particles in the water has, as a consequence, a decrease of the sterilizer's efficiency.

If the water to be treated contains sulphydric acid or more than 0.3 p.p.m. of iron or filtrable solids, once passed through the sterilizer, it leaves a residual sediment on the quartz sleeve, which, therefore, must be periodically cleaned (the frequency depends on the quantity and quality of water treated).

General directions:

According to the European rules EN 60204-1 (safety of the set-up off the electrical equipment-general rules) the low tension electrical instruments (rule 2006/95/CE) must be connected to a current-tap provided with grounding.

Electrical Safety Instructions:



The lightning flash and arrowhead symbol is to alert the user to the presence of un-insulated "DANGEROUS VOLTAGE" within the enclosure. The equipment may only be opened if main supply is isolated. The main supply must not be restored as long as the equipment is open. This applies to both the electrical panel and the UV reactor vessel.

ATTENZION: Working on live equipment is forbidden.

UV Light Danger:



The light of ultra-violet lamps can cause serious burns to unprotected skin and eyes, therefore it is recommended not to connect it to the current tap without having before ensured the UV lamp in its housing and inserted the PVC cover.

Pressure Danger:

The UV chamber could be under water pressure. Max working pressure is 10 bar. UV chamber must be installed in accordance with our installation and commissioning instructions and used in accordance with operating and maintenance instructions.

ATTENTION: Ensure that system is depressurized before attempting any service or repair

Indications for the disposal:

We remind that, according to what is fixed by D.L.25 July 2005, № 151 "Accomplishment of directives 2002/CE, 2002/96/CE and 2003/108/CE, concerning the reduction of the use of dangerous substances in electric and electronic equipments, and the disposal of waste" both mercury vapours lamps and electrical panels, when no more used, must be considered as special waste, and in the same way disposed of.

To do that, it is possible to address to specialized centres for the recovery of dangerous materials, or to contact directly our technical department.

3. Instructions for installation and setting at work

General premise: The installation of the disinfection units must be carried out by specialized staff, scrupulously following the instructions hereby given. It has been moreover considered necessary to give some general information about the electrical and water connections.

Cautions: check that the UV panel is not connected to the power supply and that the tap of the water to be treated is turned off.

- Connect the delivery of the water to be treated to the special water connection
- Turn on water and check for possible leaks in any part of the unit
- Connect the plug to the current tap
- Check that the disinfected water comes out and that the LEDS on the panel of the control board, signal the correct working

Let the disinfected water flow down to outlet for at least 10 minutes before using it, in order to make the possible impurities present in the unit drain out.

NOTE: it is recommended to install a water filter directly before the UV sterilizer in order to remove the suspended particles, eventually present in the water to be treated, which could limit the efficiency of sterilization.

CHECKS

This unit is ready for producing disinfected water, once the connection to the water system and to the electrical grid is carried out. The unit works automatically, the electronical boards which control the signals reaching the control panel, allow the visualizing (or the sounding) of the correct working or of anomalies which may occur during the operating of the unit.

3.1 Suggested Installation Scheme

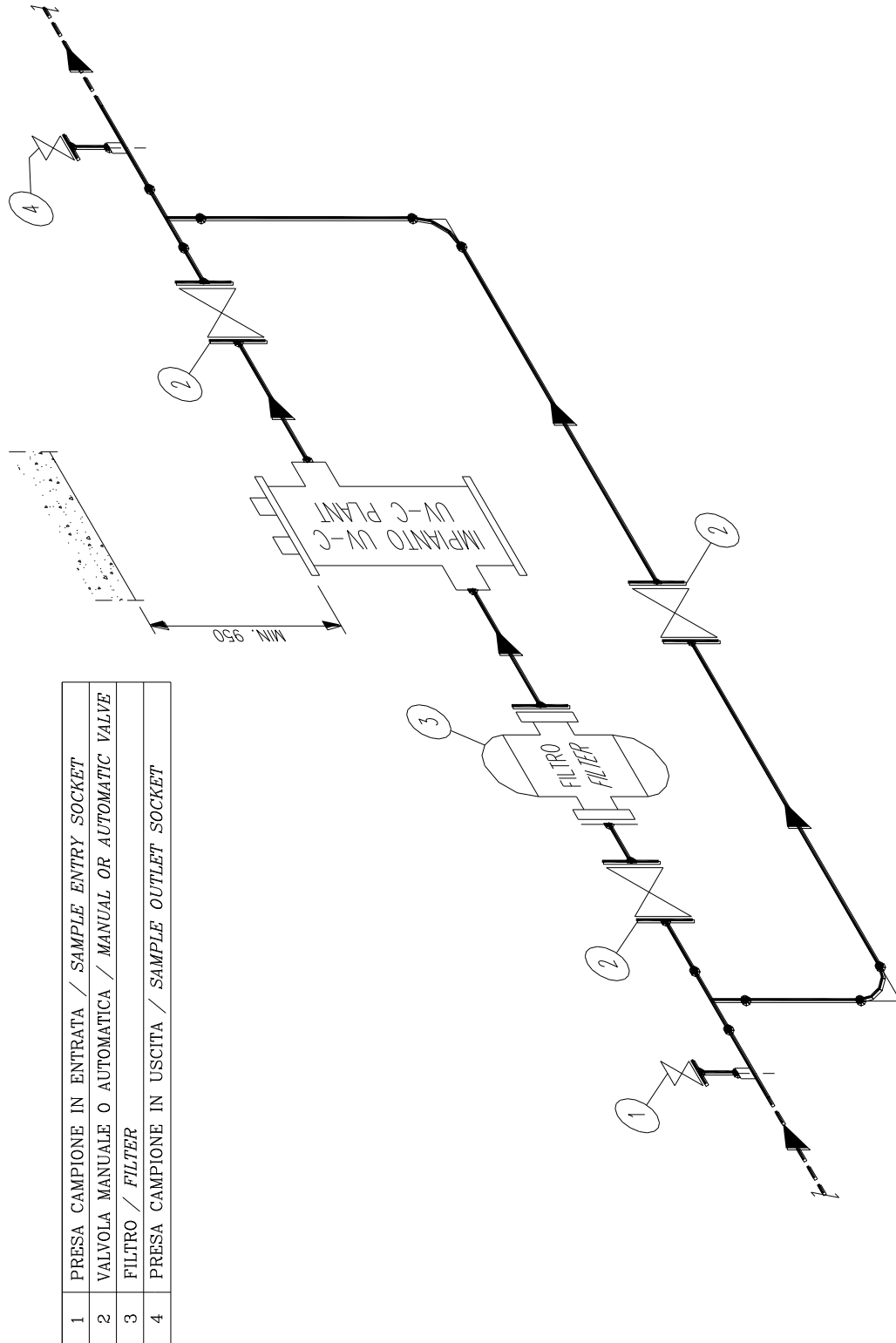

4. UV Chamber Installation

4.1 UV chamber assembling

Mount the valves kit supplied with the system .
Unscrew the sleeve bolts:



Insert the quartz sleeves carefully centring the housing at the bottom of the UV chamber:

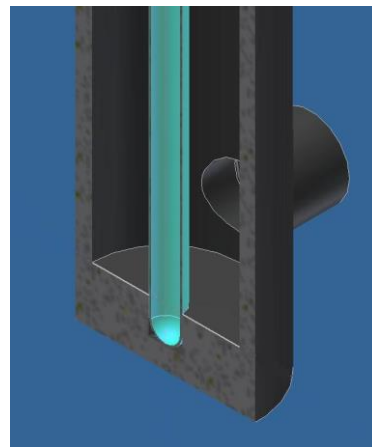

Insert the o-ring Ø 23x4 into the quartz sleeve:



Screw again the sleeve bolts and insert the lamp holder spring into the sleeve:



In case of LCD PLUS UV system: Mount the o-ring (3043 type) on the probe holder and screw this one on the $\text{\O} \frac{1}{4}$ " hole in the middle part of the UV chamber. Finally, connect the pertinent electrical cable:

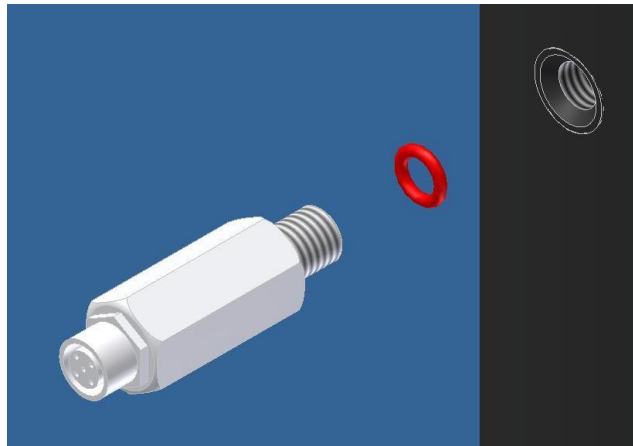

Carry out the hydraulic test, verifying that the o-rings are watertight and that there're not water leaks outside the sleeve bolts or inside the quartz sleeves.

Insert the UVC lamp into the quartz sleeve:



Important!

Handle the lamps using gloves

4.2 UV Chamber Detailed Drawing

VALIDO PER UV PE VERTICALI
VALID FOR VERTICAL UV PE

VALIDO PER UV PE ORIZZONTALI
VALID FOR HORIZONTAL UV PE

RIF./REV.	DESCRIZIONE / DESCRIPTION	CODICE / CODE	CODICE / CODE
A	LAMPADA UV / UV LAMP	0281724 PE 3 PE 60 028104 (PE 3)	028118 PE 110 PE 980
B	GUAINA AL QUARZO / QUARTZ SLEEVE	028105	028201
C	BLOCCAGUAINA NYLON / NYLON SLEEVE BOLT	028060/L	026425/316
D	O-RING	028061	028207
E	QUADRIPIN / FOUR-PIN SOCKET	028088	028089/A
F	TAPPO COPRICONTATTO PVC / PVC CONTACT COVER	028034	/
G	SENSORE Ø 1/4" / SENSOR Ø 1/4"	UV737/TF	UV737/TF
H	TRONCHETTO TEFLON / TEFLON ADAPTOR	028885	028887
I	O-RING	028218	028217
L	TAPPO PER GHIERA SERIE 400 / PLUG FOR FERRULE	/	026429
M	PORTA-QUADRIPIN SERIE 400 / FOUR-PIN SLEEVE	/	026430
N	O-RING 2112	/	OR-2112
Q	GHIERA SERIE 400 / FERRULE	/	026426
R	FLANGIA / FLANGE	028886	028888
S	O-RING 2157	028061C	/
	MOLLA SUPP. LAMP. / LAMP HOLDER SPRING	028036	/

titolo UV SERIE PE
UV PE SERIES

CODICE / F.to A4 / Scala /
Foglio 01 di 01

CLIENTE /

CLIENTE /

DESCRIZIONE /

DATA /

APPROVATO /

DESIGNATO /

SCHENONE /

MAZZONE /

LA SITA S.r.l. SI RISERVA A TERMINI DI LEGGE LA PROPRIETÀ DI QUESTO DISEGNO CON DIRITTO DI RIPRODUZIONE O DI

Voce riservata, 61 - 10137 Genova Italy - Tel. 0039-10-7406848 / Fax 0039-10-7406848 / Email: info@sita.com

La SITA S.r.l. Società Italiana Trattamento Acque

Nome File: DWG

5. Electrical panel installation and operation

5.1 Control Panel Description



CONTROL PANEL	LCD (PLUS)
Material	Thermoplastic
Dimensions	215 x 215 x 90 mm
Protection class	IP 55 (IP 65 on request)
Ambient temperature range	5 – 45 °C
Power supply	230 V - 50/60 Hz (115V – 50/60Hz on request)
Lamp cable length	1 m
Power supply cable	1 m
Monitor display	LCD SITA
Hour meter	Yes for total system life (resattable)
Resettable hour meter	Yes for lamp life control
Lamp function control	Yes
Alarm led	Yes
Free contact alarm (NO - NC)	Yes
Remote ON/OFF	Yes (settable)
230 V output	Yes – General alarm
4/20 mA output	Optional – for Irradiance and water temperature
Reactor temperature alarm	Yes – settable value (shut off for high temperature) on PLUS MODELS
UV Irradiance measurement	Yes (%) on PLUS MODELS
Acoustic buzzer	Optional

5.2 Electrical panel installation and operation

The electrical panel of the LCD series is equipped with 2 fixing brackets for wall mounting. Rotating the panel cover the user can have the cable out on the desired sides of the panel.

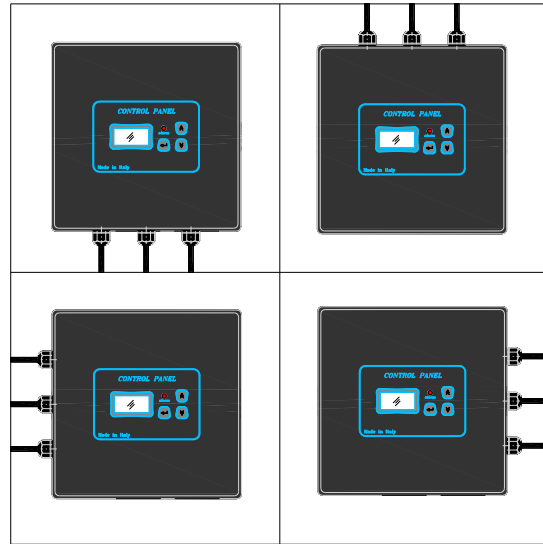
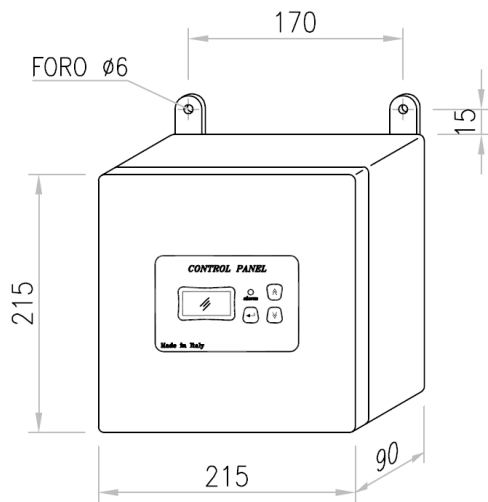

Connect the lamp socket to the lamp and close the contact cover cap, then connect the power supply plug to the main supply.



Once connected to the power supply the UV lamp will light on.

Do the following at the first start up and on every lamp replacement:

-) Activate the lamp life count down hour meter (see display description)
-) In case of LCD PLUS system with UV sensor then operate the sensor calibration. This operation must be done after at least 5 minutes from lamp start, with quartz sleeve clean, with sensor measuring window clean and with steady water flow.

5.3 Switch ON / Switch OFF the lamps

Because of the small power of the electrical panel this is not equipped with power selector. Therefore the panel is always powered but lamps can be switch ON/OFF in the following ways:

1. Keeping pushed the OK (◀↵) button for 5 seconds (see display description)
2. Closing the remote ON/OFF contact (see electrical scheme)
3. Setting the timer (see display description)

5.2 Control Panel Detailed Drawing

FILE: 30-40W LCD PLUS MONLAMPADA.DWG

MODELLO LCD LCD MODEL	CODICE SCHEDA (PLUS) BOARD CODE (PLUS)
UV 405 LCD (PLUS)	UV 652S
UV 412 LCD (PLUS)	UV 652S
UV 440 LCD (PLUS)	UV 652S
UV 480 LCD (PLUS)	UV 653S
UV 450 LCD (PLUS)	UV 654S
UV 550 LCD (PLUS)	UV 654S
UV 80/2 LCD (PLUS)	UV 655S

UV-Panel
UV DISINFECTION
MADE IN ITALY

COVER

SCHEDA ELETTRONICA B
ELECTRONIC BOARD

QUADRO ELETTRICO
ELECTRICAL PANEL

210
81
210

UV-Panel

UV DISINFECTION
MADE IN ITALY

MAZZONE APPROVATO

SCHENONE DISegnATO

10/11/14 DATA

PRIMA EMISSIONE / FIRST ISSUE DESCRIZIONE

MAZZONE APPROVATO

LA SITA S.p.A. SI RISERVA I TERMINI DI LEGGE LA PROPRIETÀ DI QUESTO PRODOTTO CON DIRITTO DI REPERIBILITÀ O DI RENDIMENTO COMUNQUE NOTO A TERZI O A DITTE CONCORRENTI SENZA LA SUA AUTORIZZAZIONE SCRITTA

0039-10-7406848 / Fax 0039-10-7406851 email info@sita.com

Via Riccardo, 61 - 16161 Genova Italy

sita S.r.l. Società Italiana Trattamento Acque

TITOLO
DISINFEZIONE UV-C /UV-C DISINFECTION

MODELLO LCD & LCD PLUS /LCD & LCD PLUS MODELS

ESPLOSO QUADRO ELETTRICO/EL. PANEL EXPLODED DRAWING

CODICE /

F.to A4 /

Scoto /

Foglio 01 di 01

CIENTE /

6. LCD Electrical Board Description

6.1 Single-lamp LCD electrical board description

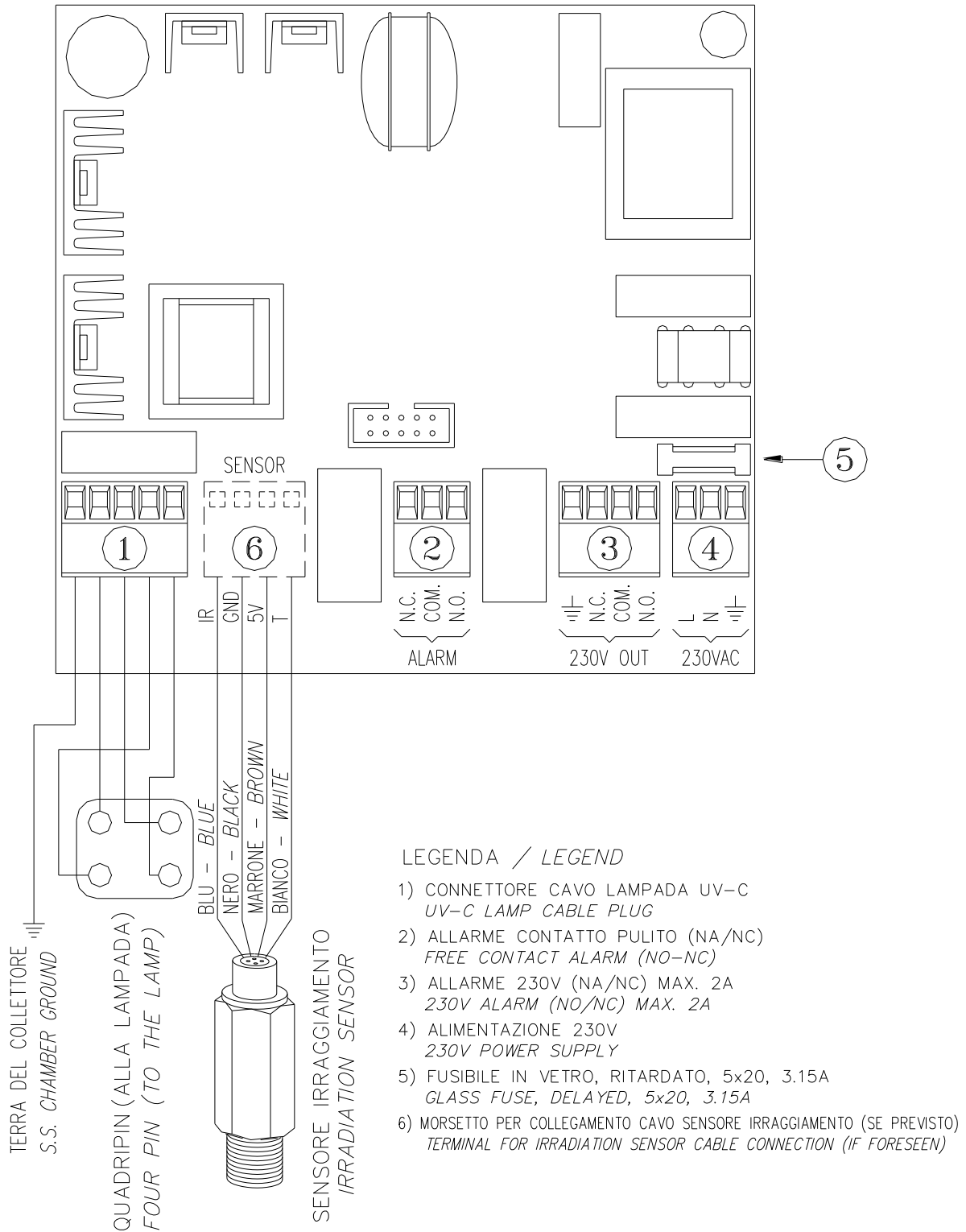

6.2 Two-Lamp LCD electrical board description

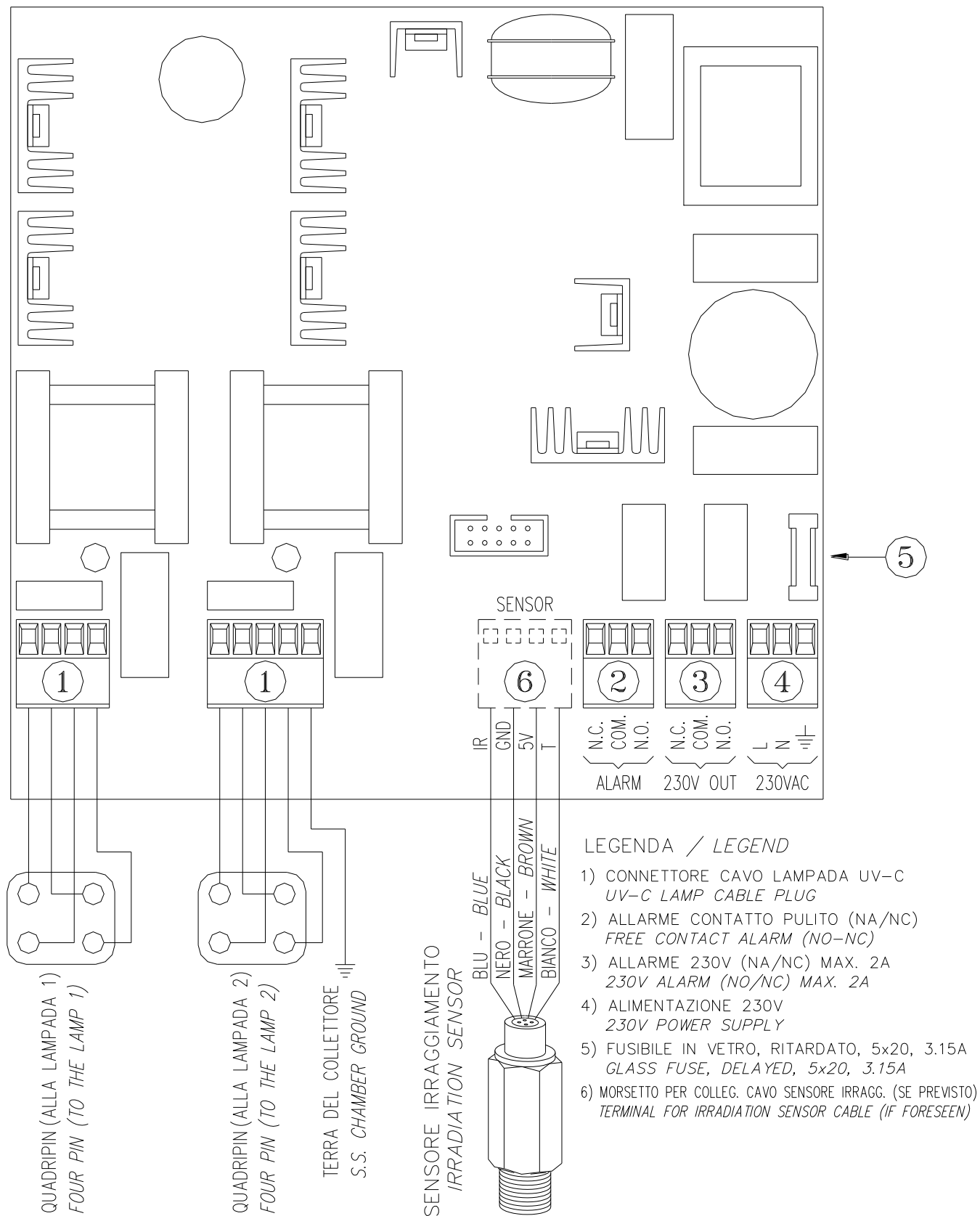

6.3 LCD Display board Description

Following are described the standard and optional terminals connection to the display board:

- It is possible to connect the sensor cable (usually this is connected on the main board).
- It is possible to connect the REMOTE ON/OFF contact, this is powered with 5Vdc that if closed to the RMT contact shuts of the lamps. The user can set the working of the remote ON/OFF contact by the display between N/O and N/C. The factory setting is N/O because it let the system working with nothing connected to the remote ON/OFF terminal.
- In case of LCD PLUS systems with optional 4/20 mA output then it's possible to connect to the 4/20 mA terminal. This signal is available for the water temperature and the UV irradiance.

The temperature signal has the following correspondence:

$$4\text{mA} = 0^\circ\text{C}$$

$$20\text{ mA} = 100\text{ }^\circ\text{C}$$

The irradiance signal has the following correspondence:

$$4\text{mA} = 0\%$$

$$20\text{ mA} = \text{Settable value on the display (factory setting } 20\text{ mA} = 100\%)$$



Important

The 4/20 mA output signal can work with a max load of 150 ohm

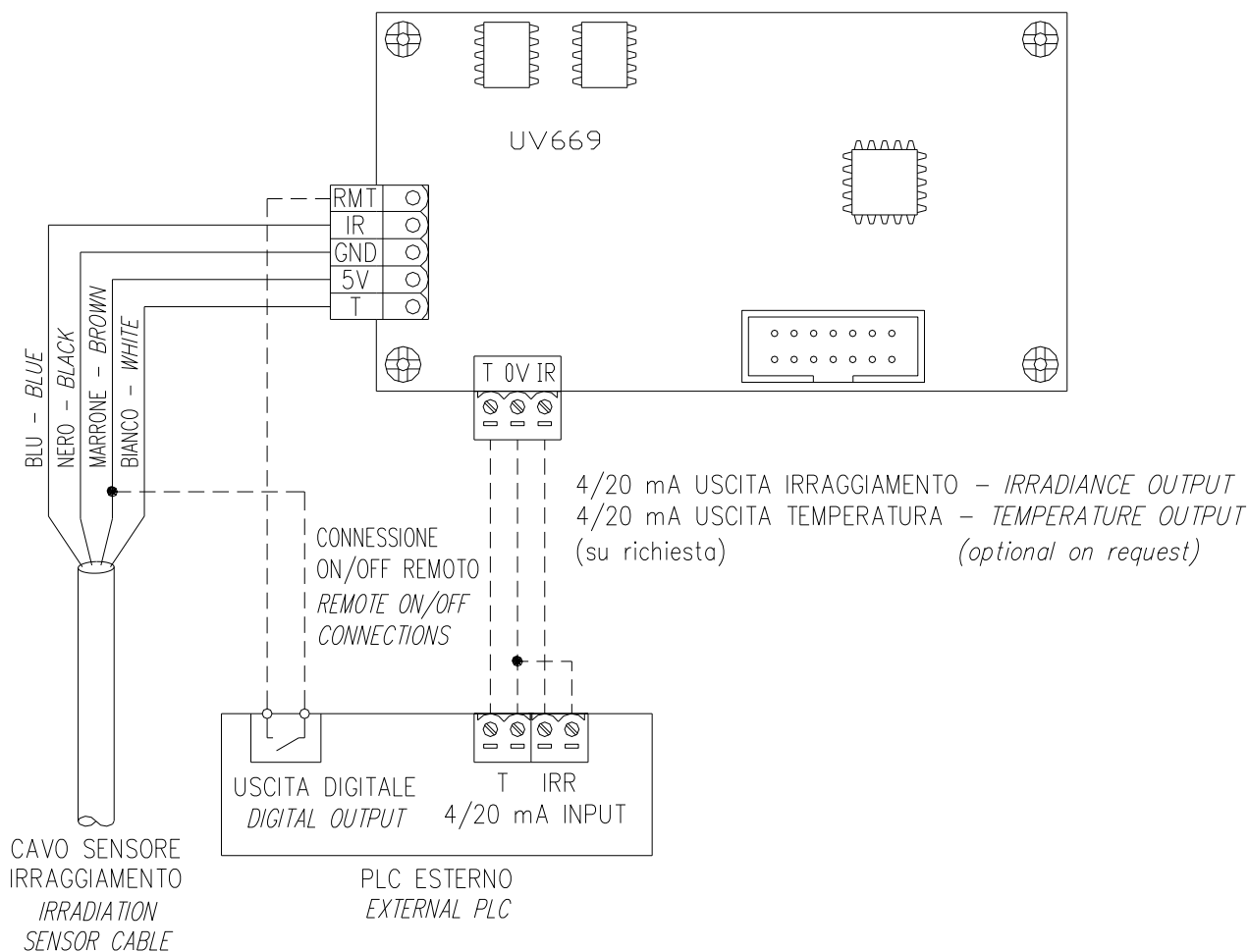

7. Display Information (Troubleshooting)

LCD DISPLAY MESSAGES – Start up:

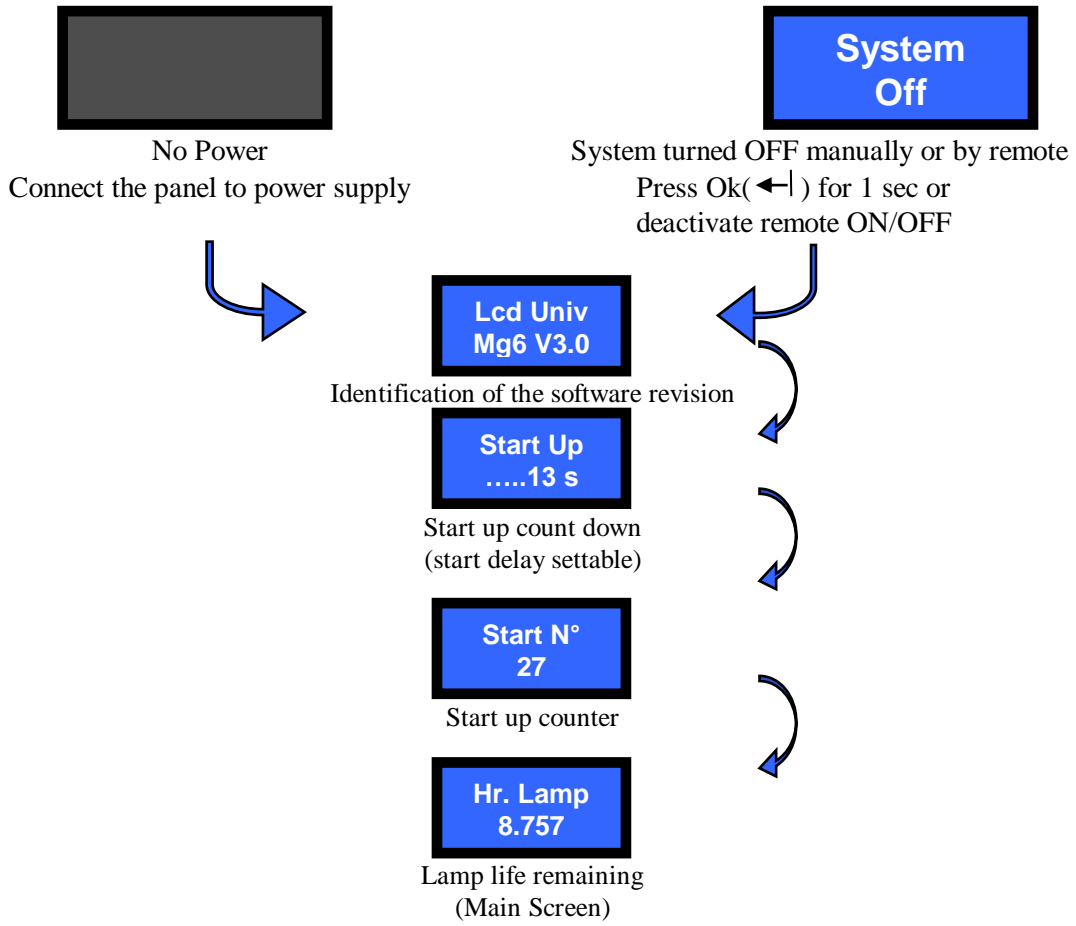

LCD DISPLAY MESSAGES – Shut Off:

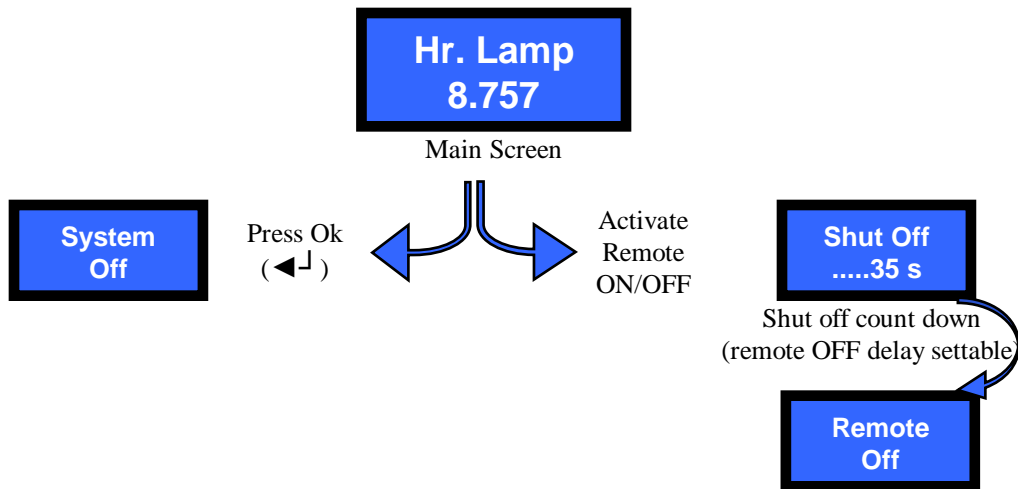

LCD DISPLAY MESSAGES – Main MENU:

The main MENU describes the main functions of the control Panel

To enter the main menus push one of the 3 buttons. Move through the menus using up and down arrow buttons.

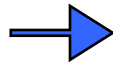
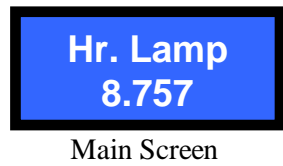

Press one Button,
move with down
and up arrow

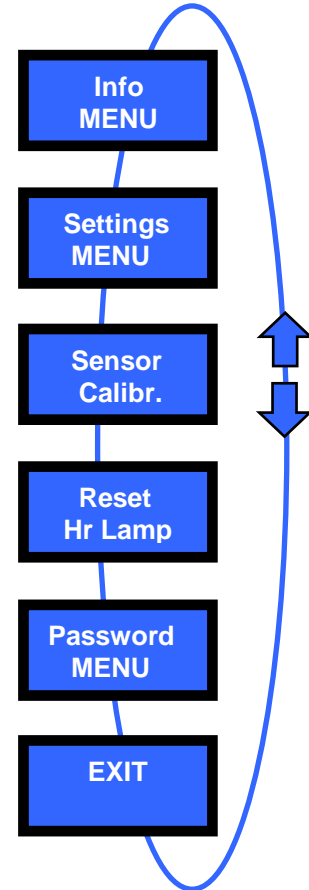
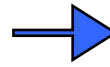

Info Menu: Press OK (◀↵) to display system working information

Settings Menu: Press OK (◀↵) to display the Settings Menu

Sensor Calibr: Press OK (◀↵) to operate the Sensor Calibration

Reset Hr Lamp: Press OK (◀↵) to restart the lamp hour meter count down.

Password Menu: This menu is protected by password and it is for Factory Settings

Exit: Press OK (◀↵) to return to normal working display

NOTE: After 3 seconds the display returns to the main screen.

LCD DISPLAY MESSAGES – Info MENU:

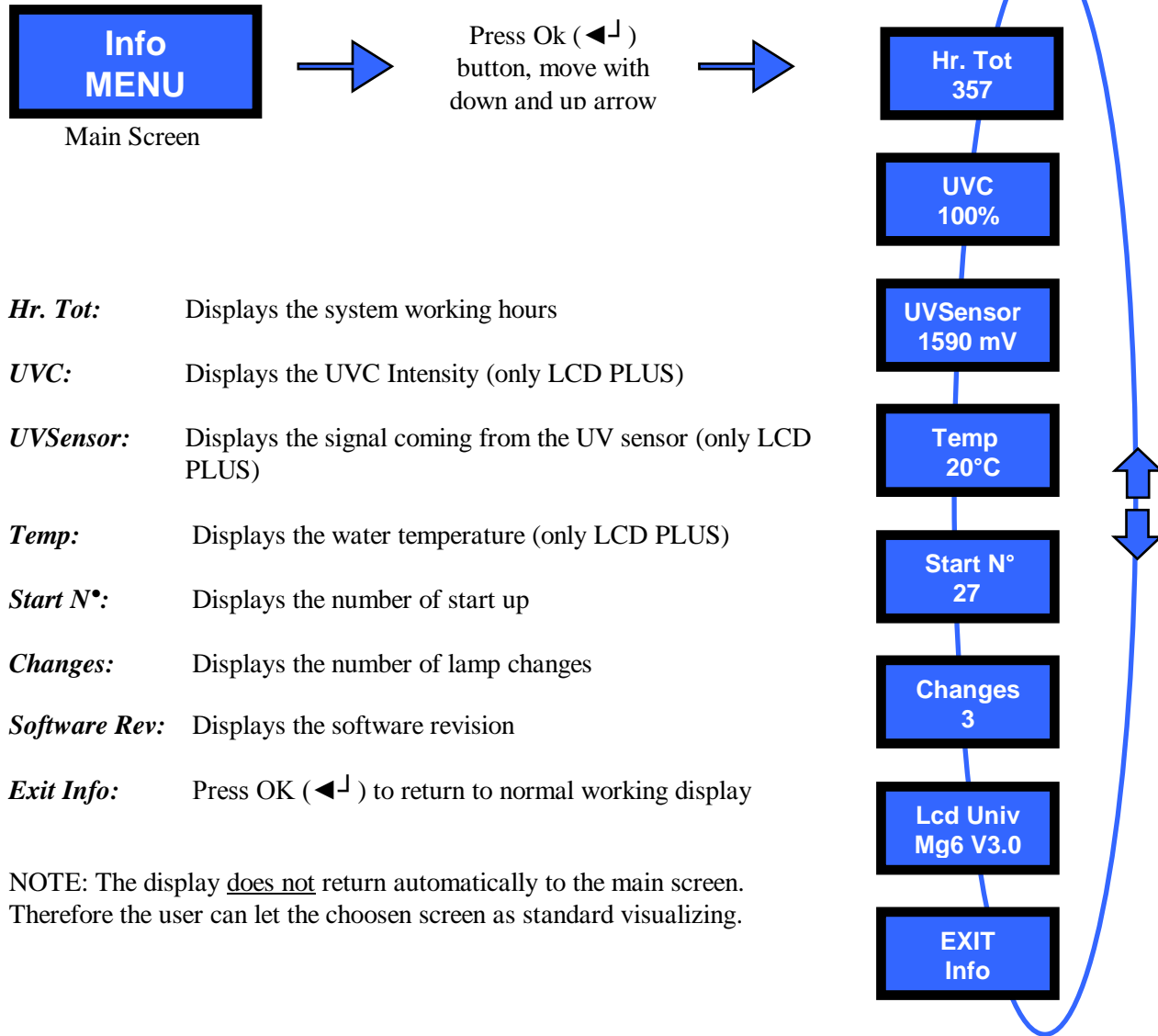

NOTE: The display does not return automatically to the main screen. Therefore the user can let the choosen screen as standard visualizing.

LCD DISPLAY MESSAGES – Settings MENU:

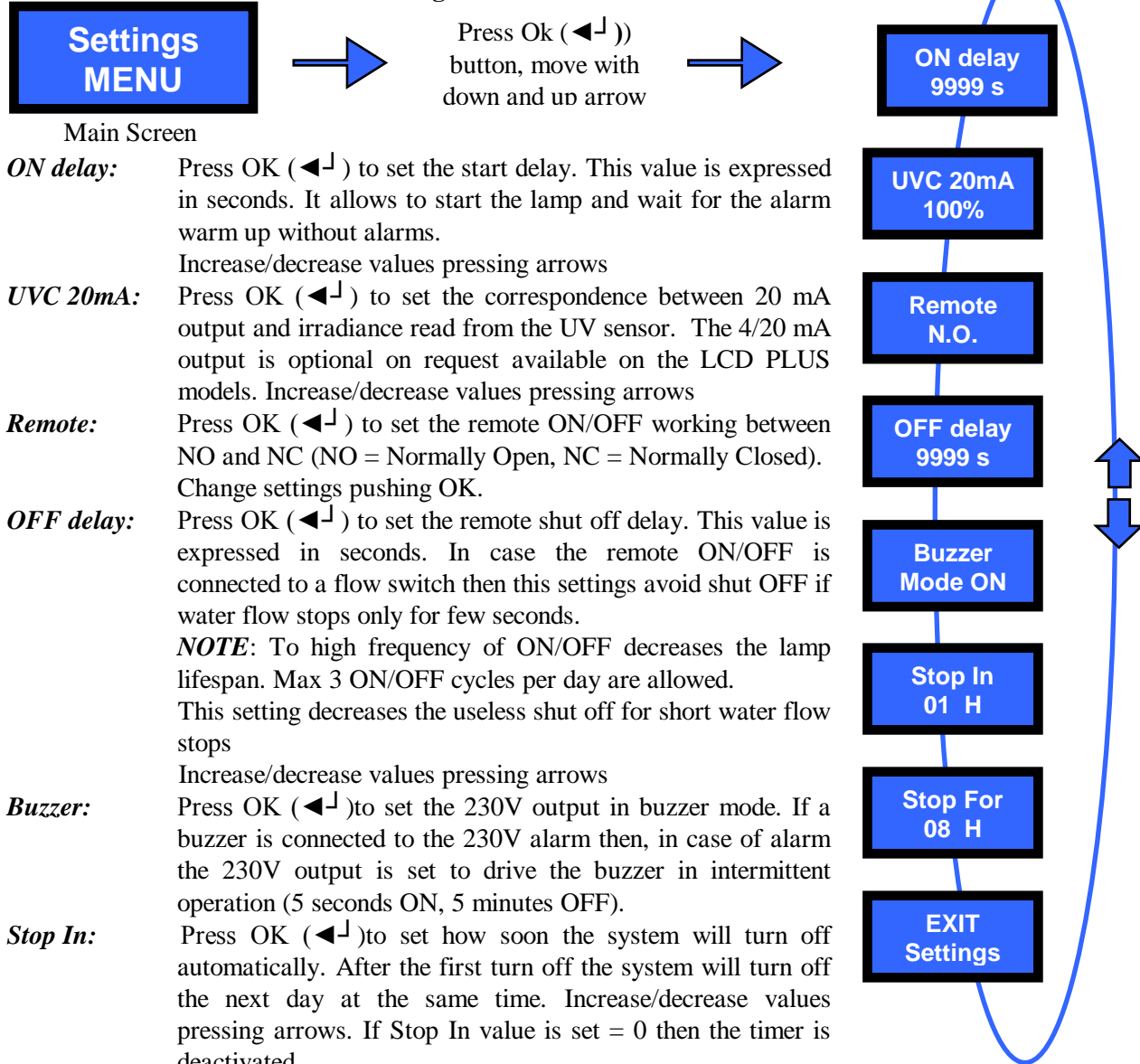

ON delay: Press OK (◀↵) to set the start delay. This value is expressed in seconds. It allows to start the lamp and wait for the alarm warm up without alarms.
Increase/decrease values pressing arrows

UVC 20mA: Press OK (◀↵) to set the correspondence between 20 mA output and irradiance read from the UV sensor. The 4/20 mA output is optional on request available on the LCD PLUS models. Increase/decrease values pressing arrows

Remote: Press OK (◀↵) to set the remote ON/OFF working between NO and NC (NO = Normally Open, NC = Normally Closed). Change settings pushing OK.

OFF delay: Press OK (◀↵) to set the remote shut off delay. This value is expressed in seconds. In case the remote ON/OFF is connected to a flow switch then this settings avoid shut OFF if water flow stops only for few seconds.

NOTE: To high frequency of ON/OFF decreases the lamp lifespan. Max 3 ON/OFF cycles per day are allowed.

This setting decreases the useless shut off for short water flow stops

Increase/decrease values pressing arrows

Buzzer: Press OK (◀↵) to set the 230V output in buzzer mode. If a buzzer is connected to the 230V alarm then, in case of alarm the 230V output is set to drive the buzzer in intermittent operation (5 seconds ON, 5 minutes OFF).

Stop In: Press OK (◀↵) to set how soon the system will turn off automatically. After the first turn off the system will turn off the next day at the same time. Increase/decrease values pressing arrows. If Stop In value is set = 0 then the timer is deactivated

Stop For: Press OK (◀↵) to set how long the system will remain off before automatic restart. Increase/decrease values pressing arrows. If Stop In value is set = 0 then the timer is deactivated.

Timer Diagram example with Stop In set to 4 hours and Stop For set to 10 hours:

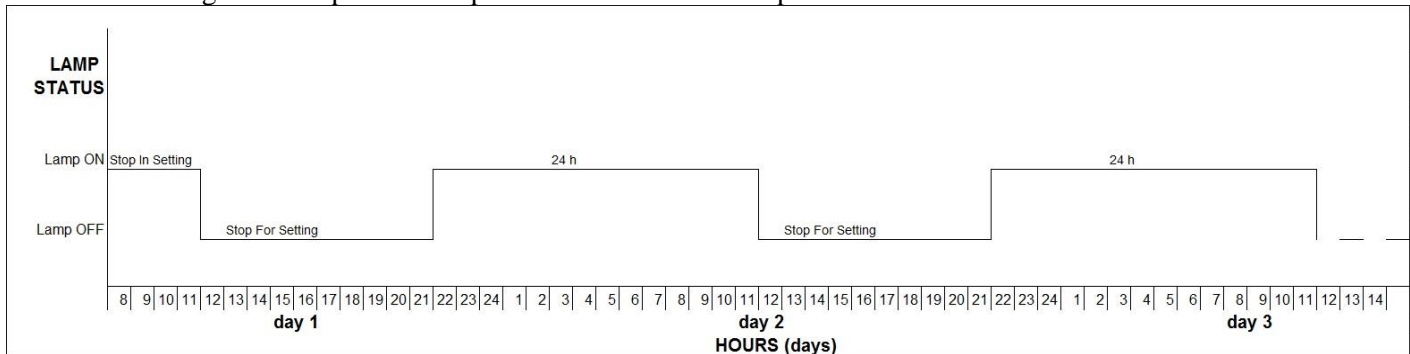

Exit: Press OK (◀↵) to return to normal working display

NOTE: After 3 seconds the display returns to the main screen.

LCD DISPLAY MESSAGES – Sensor Calibr. (Only PLUS version):

This operation must be done at the first start up and on every lamp replacement, with quartz sleeves and sensor measuring window clean. Wait 5 minutes from the lamp start before operating the sensor calibration.

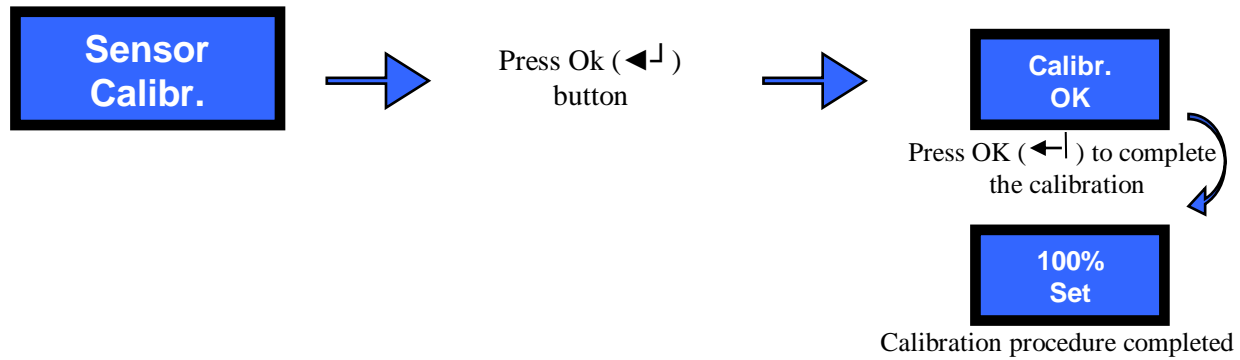

LCD DISPLAY MESSAGES –Reset Hr Lamp.:

This operation starts the count down of the lamp life hour meter. This operation must be done at the first lamp start and on every lamp replacement

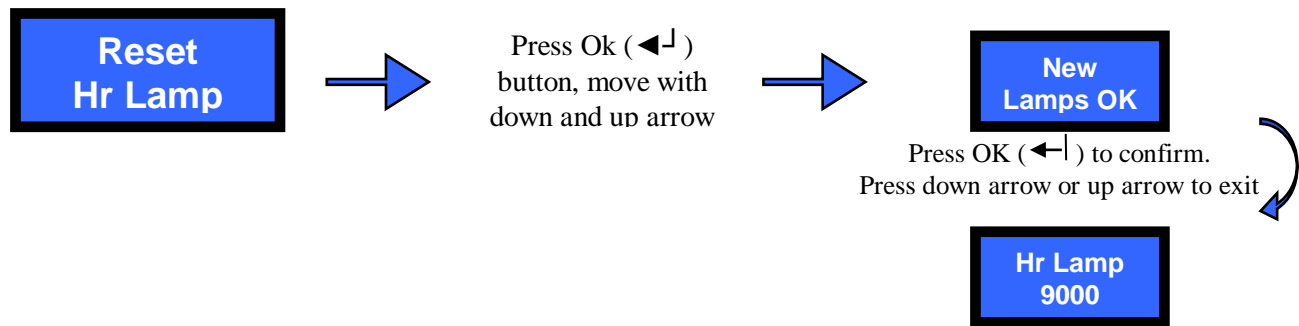

LCD DISPLAY MESSAGES – Alarms/troubleshooting:

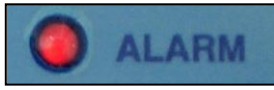

In case of any alarm the red LED is flashing.

List of alarms:



Indicates the lamp failure. If the system has 2 lamps the failed lamp is identified. Check:

- Connection to the lamp
- If lamp has failed
- If lamp starter has failed.



Indicates that the count-down hour meter of lamps life comes to zero. In such case replace the lamps and restart lamp hour.

Only for Plus

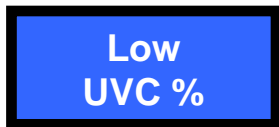

Indicates low irradiation. Check:

- If lamp life has expired
- If quartz sleeves are dirty
- If sensor windows is dirty
- If water quality has changed



Indicates high temperature in the UV chamber. This may happen when either there is no flow or there is air in the UV chamber. In such cases the system switches off.

Reset the alarm: Push OK (◀) for 5 sec to put the system in standby then press OK (◀) again to restart the UV system.

NOTE: In case of high temperature the panel turns off the lamp and this remains off even if temperature drops below the threshold level. This is necessary in case of no flow to avoid this cycling:

Lamp ON → High Temperature → lamp turned off → Temperature lower than threshold → lamp started again → High Temperature →

This can destroy the UV lamp, in case the user can accept this risk then ask the factory for setting change instructions.

LCD DISPLAY MESSAGES – Other Problems:



Display OFF in case of no electrical feeding or burned fuses

8. Maintenance

The UV System have been projected and realized with simple and functional principles which make the checking procedures and the periodical servicing particularly easy.

The main points which characterize the ordinary servicing are the following: check quarterly the quartz sleeves, which contain the UV lamps, in order to ensure the maximum disinfection, for the cleaning.

Maintenance work may only be carried out by personnel who have been trained and authorized for this work by the owner and/or user. The owner and/or user must ensure that the maintenance personnel are familiar with the safety measures and regulations, and that they also comply with them, in addition to having read and understood the operating instructions.

Only original replacement parts from the supplier must be used.

The following are the recommended service intervals for replacement parts:

UV lamp change - once per 9000 hours

UV quartz sleeve clean - frequency depends on the quality of the water

O-ring for quartz sleeve-once per year

Procedure for the UV lamp replacement (9000 h max.)

- 1) Disconnect the electrical box from the electrical power supply
- 2) Lift the cover slightly turning, carefully loosen the electrical 4-pins connection and extract the lamp from the quartz sleeve
- 3) Remove the lamp from the packing, handling it carefully by its ends or using gloves
- 4) Insert the new lamp into the quartz sleeve of the sterilizer
- 5) Connect the lamp to the electrical connection and put again the cover
- 6) Connect again the equipment.

Important!

For lamps replacement it is not necessary to stop the water flow and drain the UV chamber

Procedure for the quartz sleeve cleaning

- 1) Disconnect the electrical box from the electrical grid and turn off water
- 2) Remove the lamp, as for the replacement
- 3) Depressurized and drain the UV system
- 4) Unscrew the sleeve-bolt and extract the quartz sleeve with care
- 5) Clean the quartz sleeve by wiping it with a cloth soaked with an acid solution such as vinegar or lemon
- 6) Reassemble the sleeve being sure to center the guide-spring fixed on the bottom, put the o-ring on the quartz sleeve, then tighten the sleeve-bolt; place the o-ring in the seat of the sleeve-bolt, insert the sleeve inside it, till it leans, then screw on the S/S chamber.
- 7) Turn on water checking for eventual leaks
- 8) Mount again lamp, its electrical connection and cover
- 9) Turn on the UV system.

9. Warranty Conditions

WARRANTY CONDITIONS

SITA works in compliance with ISO 9001-2008 quality procedures and subjects all equipments to accurate checks and tests.

The SITA supplies and progressing are anyway guaranteed only in the limits of technical specifications and request and/or of the certificates and/or of the specific checks as agreed, for 24 months from the delivery date or 30 days from the purchase date, provided that eventual defects are stated as fixed by art. No. 1495 of the civil code.

The stainless steel chamber is covered by warranty of 5 years only if used for compatible liquids and correctly installed.

In no case the integral replacement of the product is foreseen and any responsibility of Sita is excluded for delays in the delivery of the goods to the customer, for claims of third parties towards the customer, for losses of goods, costs (installation, servicing and maintenance, transports, and so on) and damages of the customer due to the defect.

Moreover the product repaired or tampered by non-authorized third parties, and the product on which an intervention has been made for defect or for convenience tests, is excluded from the warranty.

Repairs are normally carried out in SITA warehouse or in authorized after-sales service centers signalled by SITA.

The warranty does not cover:

1. Accidental breakages due to the transport.
2. Breakages due to the use of equipments not in compliance with what is indicated on the use and maintenance manual or to carelessness.
3. Breakages to the connection to a power grid fed with a tension different than the foreseen one ($\pm 10\%$ of the nominal value as fixed by CEI rules)

DO NOT TAMPER THE ADHESIVE LABELS OF IDENTIFICATION

The adhesive label with the QC (Quality Control) number must be intact and readable; such number allows to enter the data bank of tests and to find the values obtained in the electrical test of the equipment.

The adhesive label with the S/N (Serial Number) number must be intact and readable; such number allows to enter the data bank of tests and to find the values obtained in the hydraulic test of the equipment.

In case of dispute the court of Genova will be competent.

10. Declaration of Conformity EC

EC DECLARATION OF CONFORMITY

The undersigned hereby declares, under full responsibility, that the unit:

UV DISINFECTION SYSTEM

Complies with what is foreseen by

2006/95/CE (low voltage directive)

2004/108/CE (electro-magnetical compatibility)

2002/95/CE (RoHS)

2002/96/CE (WEEE)

IEC -EN 60204-1 norms (safety of machinery-electrical equipment of machinery)

IEC -EN 55022 norms (characteristics of radio interference)

D.Lgs. 31/2001 (Implementation of Directive 98/83/CE on the quality of water intended for human consumption)

97/23/CE (art.3 comm.3) (PED)

The validity of CE marking is subordinated to the equipment integrity. Any modification, if not authorized, will cancel the use of the CE marking. This will occur in case the relevant risks have not been previously analyzed by our Company, and a new EC Declaration of Conformity has been issued.